

DISTRIBUTOR/AGENT:	DATE OF ORDER:
	DATE OF DELIVERY:
	NAME OF THE ADDRESSEE/USER:



Product marked

FEATURES

- **Ergonomic and modular tricycle** that helps the user to keep a proper posture and makes the ride easier thanks to its design and components.
- **Lowered frame** for easy ascent and descent.
- **Front positioned bottom bracket** for easier pedaling.
- **Optimized pinion** to facilitate the pedaling in safety.
- **Adjustable handlebar** in height, backward-forward and reversible.
- **Wide and ergonomic handles**, to increase comfort.
- **Bell.**
- **Back led lamp.**
- **Cranks adjustable** in length.
- **Front brake with locking device** for ascent and descent, that can be operated by the thumb-lock stopper either on the right or on the left side of the handlebar. The distance between the brake lever and the handlebar is adjustable by screw.
- **Adjustable ergonomic saddle** in height, tilt and backward-forward
- **Rear storage basket.**
- **12" solid wheels.** A mechanism on the rear wheels allows easy adjustment of the tension of the chain.



Attention!
Read carefully the user and maintenance manual

Please check off the interested products:

MEASURES

FRAME COLOUR:

- Blue
- Red
- Pink

View from above

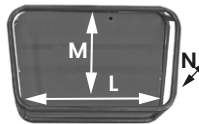

Storage basket
Internal measures

L	41 cm	In 16
M	18 cm	In 7
N	6,6 cm	In 2,6
Max. Load	15 kg	Lb 33

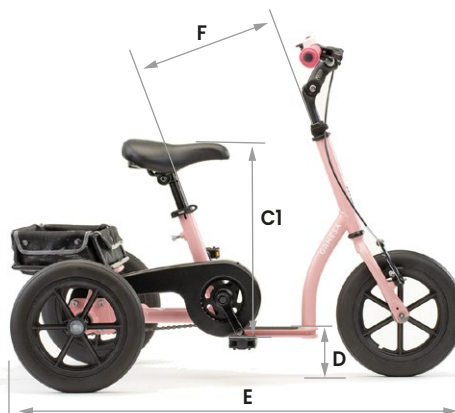

C1= C2-2cm

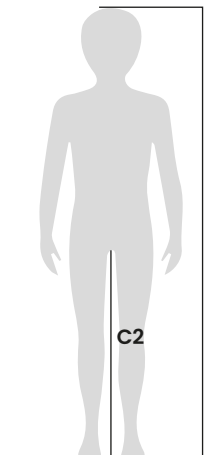

C2= leg length

	Max. load	Aid weight	A	B	C1*	D	E	F	Use height(H)
size mini	Kg. 30 lb. 66,1	Kg. 15,5 lb. 34,1	cm 45 in. 17,7	cm 62 in. 24,4	cm 39-53 in. 15,3-20,8	cm 12 in. 4,7	cm 103 in. 40,5	cm 36 in. 14,2	cm 90-110 in. 35,4-43,3

*With standard saddle. You can further adjust the height of the saddle (3cm ±) acting on the clamp.

CHOOSE THE CONFIGURATION >

Fixed Pinion

Free Wheel

Please **CHOOSE THE POSITION OF THE BRAKE** on Standard Handlebar or on Ergonomic Handles 880.

Left Right

In the absence of indications, the brake will be mounted on the right.

OPTIONAL COMPONENTS, ALSO CHOOSABLE SEPARATELY

880 Ergonomic handles adjustable in inclination independently (1 pair). Same size as the Handlebar.

Choose the position of the brake on Ergonomic Handles





845 Forearm support

Left Right



875 Wrist retainer with support and multi-adjustable glove independently.

Left Right





842P Pelvic support with belt, adjustable in height.
Also select the component 883



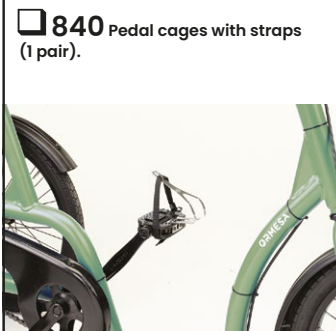

842T Trunk support, adjustable in height, inclination and backward-forward with belt and joint.
Also select the component 883

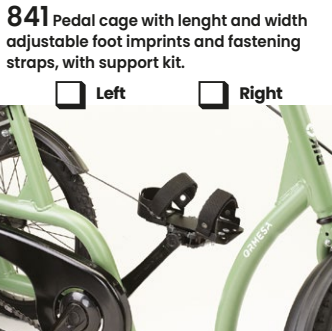
883 Rod adjustable in height for Thoracic/Pelvic support (single rod).
Please select even the type of support.

877 Flat backrest



843 Abductive saddle with holder for supports



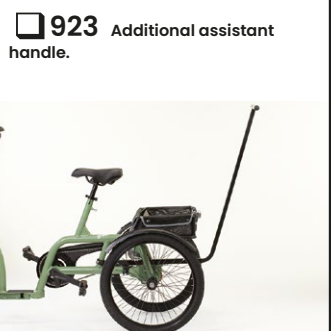

840 Pedal cages with straps (1 pair).

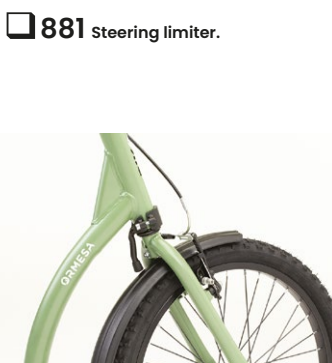

841 Pedal cage with length and width adjustable foot imprints and fastening straps, with support kit.

Left Right



846 Ankle support adjustable in height, with support kit. Only with component 841.

Left Right

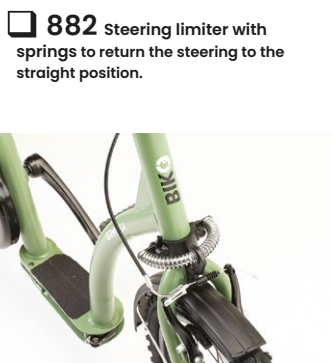

923 Additional assistant handle.

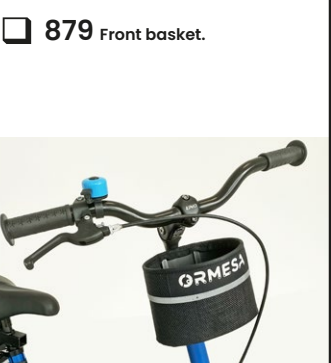
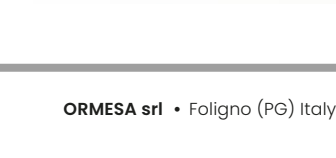
963 Steering assistant handle adjustable in height.

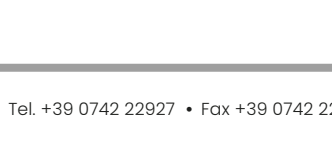

881 Steering limiter.



882 Steering limiter with springs to return the steering to the straight position.

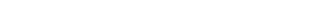

879 Front basket.

COMPONENTS
MEASURES

842P

	A
mini/s	8,5-14 cm/in 3,3-5,5
M	8,5-21 cm/in 3,3-8,3
L/XL	8,5-23 cm/in 3,3-9

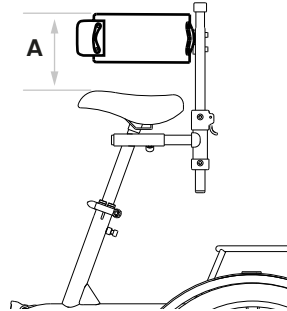

842T

	A
mini/s	19-30,5 cm/in 7,4-12
M	19-40 cm/in 7,4-15,7
L/XL	19-46 cm/in 7,4-18,1

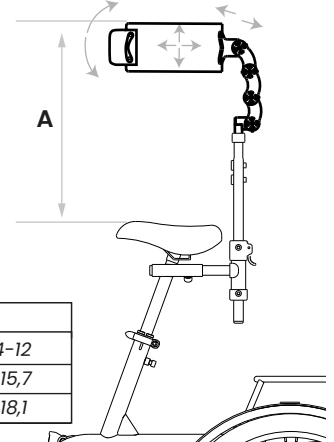

842P - 842T

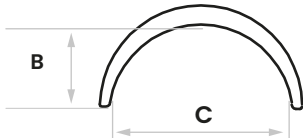

	B	C
mini/s	10,5 cm/in 4,1	23 cm/in 9
M	12,5 cm/in 4,9	31 cm/in 12,2
L/XL	17,5 cm/in 6,8	35 cm/in 13,7

843

	A	B
mini/s	31 cm/in 12,2	12,5 cm/in 4,9
M/L/XL	40 cm/in 15,7	14 cm/in 5,5



876

A	31 cm 12,2"
B	13,5 cm 5,3"
C	9 cm 3,5"

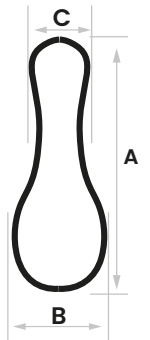

841

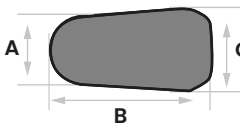

841 foot imprint size			
	A	B	C
mini/s	from 5 to 7 cm from 1,9 to 2,7 in	from 12,5 to 16,5 cm from 4,9 to 6,5 in	from 6 to 7 cm from 2,3 to 2,7 in
M/L/XL	from 8,2 to 9,4 cm from 3,2 to 3,7 in	from 20 to 22,5 cm from 7,8 to 8,8 in	from 10,4 to 12 cm from 4 to 4,7 in

Standard handlebar

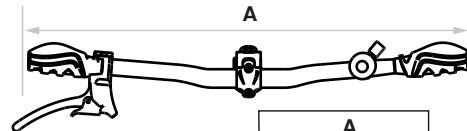

	A
mini	45 cm / in 17,7
S	50 cm / in 19,6
M	55 cm / in 21,6
L	60 cm / in 23,6
XL	64 cm / in 25,2

Notes:-----
